

# ATSAMD21J18

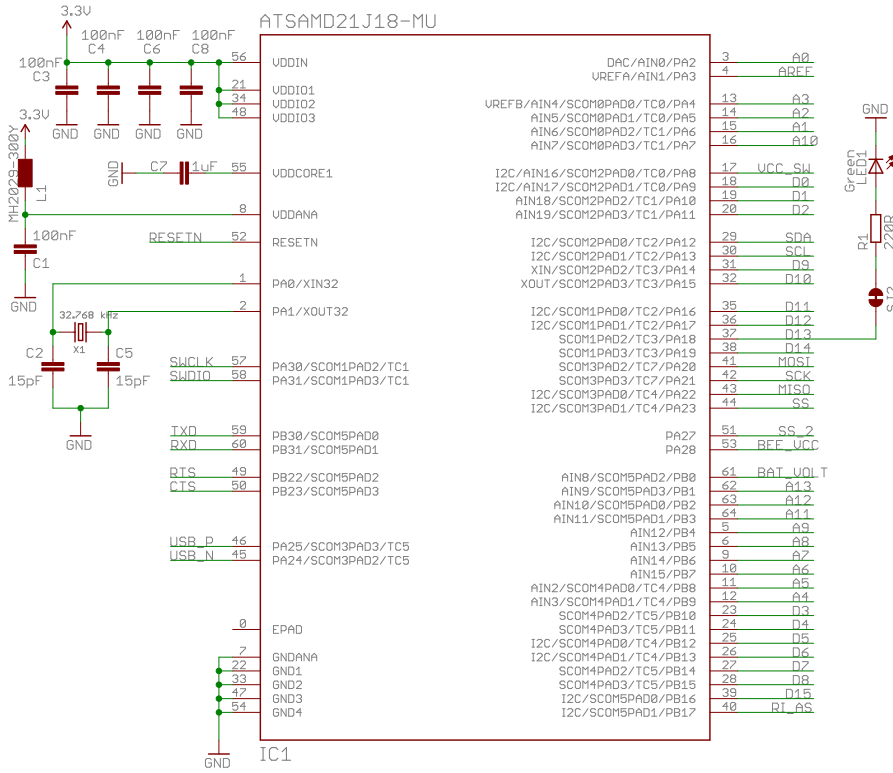

## LIPO CHARGER

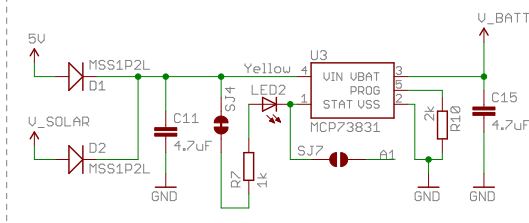

## 3.3 VOLT SWITCHED

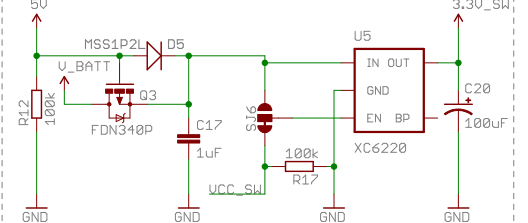

## 3.3 VOLT

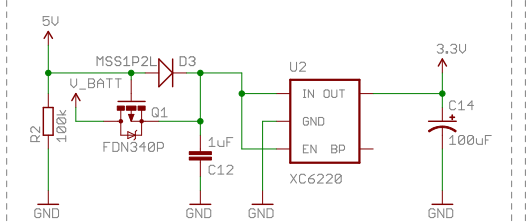

## BEE Vcc

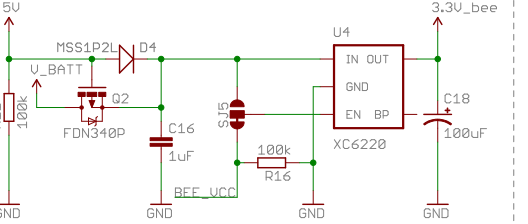

## SERIAL WIRE

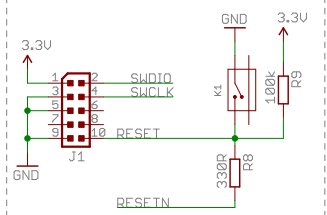

## USB

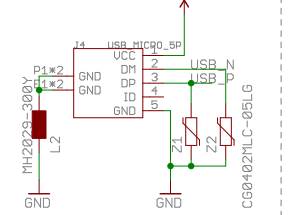

## SERIAL FLASH

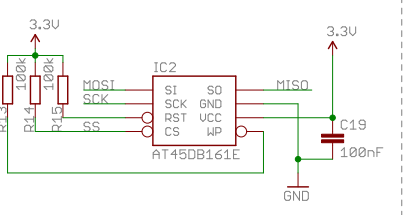

## HEADERS

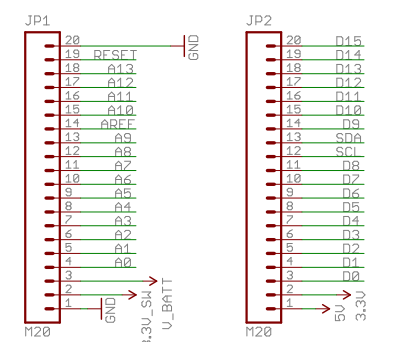

## BEE

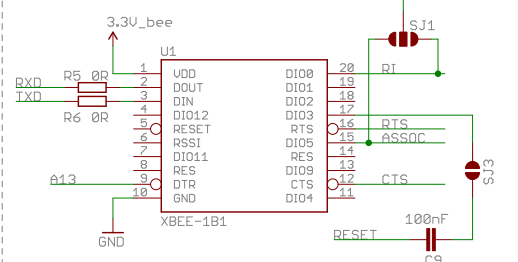

## JST

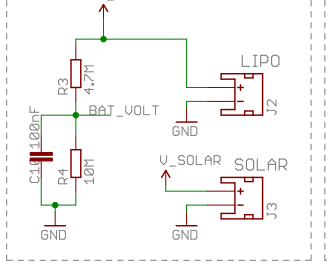

## µSD-CARD

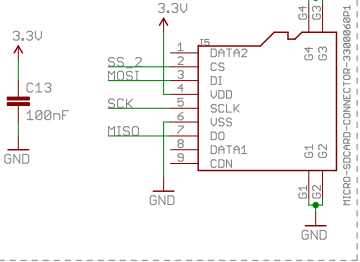

## SODAQ

TITLE: sodayq_autonomo_rev3	REV: 3
Design by: Gregory Knauff [GKNFF]	
Date: 20-7-2015 08:55:32	Sheet: 1/1